



Operating instructions

V-ZUG-Home

Thank you for choosing to buy one of our products. Your appliance is made to high standards and is easy to use. Nevertheless, please take the time to read these operating instructions in order to familiarize yourself with V-ZUG-Home and get the best use out of the appliance.

Please follow the safety precautions.

Modifications

Text, diagrams and data correspond to the technical standard of the appliance at the time these operating instructions went to press. The right to make technical modifications for the purpose of the further development of the appliances is reserved.

Validity

These operating instructions apply to:

All appliances with V-ZUG-Home.

Variations depending on the model are noted in the text.

Contents

1	Safety warnings	4	7.5	Refrigerating and freezing appliances.....	25
1.1	Symbols used.....	4	7.6	V-ZUG-Home factory settings.....	26
1.2	General safety precautions.....	4	8	Trouble-shooting	26
1.3	Appliance-specific notes	4	8.1	Via WLAN-connected household appliances	26
2	Using for the first time	5	8.2	Via LAN-connected household appliances.....	28
2.1	Conditions.....	5	9	Index	29
2.2	Checking the connection type	5	10	Service & Support	31
3	Module description	7			
3.1	Modes.....	7			
3.2	Symbol status.....	9			
4	Connecting the household appliance via WLAN	10			
4.1	Installing the app	10			
4.2	Enabling the V-ZUG-Home mode on the household appliance.....	10			
4.3	Connecting the household appliance to the home network.....	10			
4.4	Setting up remote access.....	11			
5	Connecting the household appliance via LAN	12			
5.1	Connecting the network cable	12			
5.2	Connecting the household appliance to the home network.....	12			
5.3	Enabling the V-ZUG-Home mode on the household appliance.....	13			
5.4	Connecting the smartphone or tablet to the household appliance.....	13			
6	Enabling V-ZUG-Home mode	13			
6.1	Ovens, cookers, steamers and microwaves ..	13			
6.2	Washing machines and tumble dryers.....	14			
6.3	Dishwashers	15			
6.4	Hobs.....	16			
6.5	Refrigerating and freezing appliances.....	16			
7	V-ZUG-Home configuration	16			
7.1	Ovens, cookers, steamers and microwaves ..	16			
7.2	Washing machines and tumble dryers.....	21			
7.3	Dishwashers	23			
7.4	Hobs.....	24			

1 Safety warnings

1.1 Symbols used



Denotes important safety precautions.

Failure to observe said precautions can result in injury or in damage to the appliance or fittings!



Information and precautions that should be observed.



Information on disposal



Information about the Operating Instructions

- ▶ Indicates step-by-step instructions.
 - Describes how the appliance reacts to the steps taken.
- Indicates a list.

1.2 General safety precautions



- Read the operating instructions before using the appliance for the first time.

1.3 Appliance-specific notes

Before using for the first time

- Internet access is required for full use of V-ZUG-Home.
- Before using a newly installed appliance for the first time, please follow the tips in the «Using for the first time» section (see page 5).

Correct use

- Any repairs, modifications or manipulations to the appliance, especially any electrically live parts, may only be carried out by the manufacturer, its Customer Services or a similarly qualified person. Repairs if carried out incorrectly may cause serious injury, damage to the appliance and fittings, as well as af-

fect the functioning of the appliance. If the appliance is not working properly or in case a repair is needed, follow the instructions given in the «Service and support» section. Please contact our Customer Services if necessary.

Note on use

- During operation, microwave appliances can interfere with the WLAN network. In certain circumstances this may lead to limitations on the use of V-ZUG-Home or other applications that communicate via WLAN. Where possible, select the «automatic» channel setting on your WLAN router and avoid channels 8–13.
- The V-ZUG-Home module operates at a frequency band of 2.4–2.5 GHz and has a maximum radiated transmission power of 20 dBm.

2 Using for the first time

2.1 Conditions

The following conditions must be met for full use of V-ZUG-Home:

- Access to the internet and to Google Play™ Store / App Store®
- Smartphone or tablet that is connected to the home network
- System requirements for smartphone or tablet: from Android 6.0 or from iOS 11.0
- For connection via WLAN only: a wireless network that meets one of the following standards: 2.4GHz 802.11 b/g/n



Google Play™ is a trademark of Google Inc.



Apple and the Apple logo are trademarks of Apple Inc., registered in the U.S. and other countries. App Store® is a service mark of Apple Inc.

2.2 Checking the connection type

Depending on the type of appliance and model number, your household appliance is connected to your home network via LAN or WLAN.

- ▶ The model number can be found on the identification plate of the household appliance (corresponds to the first 5 alphanumeric characters of the serial number).
- ▶ Depending on the model number, connect the household appliance to the home network via LAN (see page 12) or WLAN (see page 10).

WLAN

Type of appliance	Model designation	Model number
Ovens and cookers	Compair SL SLP XSL XSLP	21092–21101
	Compair V200 V400 V600	21036–21041, 21074–21076, 21084, 21126, 22017–22027
	Compair V2000 V4000 V6000	21042–21059, 21064–21070, 21072, 21073, 21077–21083, 21085–21091, 21110, 21112–21120, 21124, 21125
Steamers	Combi-Steam HSL XSL, Compair-Steam SL	23062–23071
	Combi-Steam MSLQ	23072, 23073
	Steamer V4000	23024–23026
	CombiSteamer V4000 V6000	23027–23034, 23041, 23043, 23045–23047
	CompairSteamer V2000 V6000	23035–23040, 23048, 23049, 23056–23061, 23098, 23100, 23103–23106
Microwaves	CombiMiwell V2000 V4000	24021, 24022, 24025

2 Using for the first time

Type of appliance	Model designation	Model number
Hobs	GK11TIXFK FullFlex	31093
	CookTop V6000 I705 FullFlex V6000 I905 FullFlex	31132, 31134
Dishwashers	Adora SL SL WP	41127–41140
	AdoraDish V2000 V4000 V6000	41091, 41093–41125
Washing machines	AdoraWash V2000 V4000 V6000	11021, 11023, 11025, 11041–11043
Tumble dryers	AdoraDry V2000 V4000 V6000	12011–12013, 12017–12019
	CombiAdoraDry V4000	12014
Refrigerating and freezing appliances	CombiCooler V400 V2000 V4000	51086, 51100, 51101
	CombiCooler V2000 178NI V2000 152NI V4000 178NI V4000 178KNI	51106–51108, 51114
	WineCooler V4000 90 45	51102, 51113

LAN



Household appliances with LAN connection were only available in Switzerland but are no longer offered.

Type of appliance	Model designation	Model number
Ovens and cookers	Combair SL SLP XSL XSLP	21021–21025, 21028–21030
Steamers	Combi-Steam HSL XSL, Combair-Steam SL	23003–23008, 23011–23013
	Combi-Steam MSLQ	23014, 23015
Hobs	GK11TIFKZ/S FullFlex	31062
Dishwashers	Adora SL SL WP	41056, 41058, 41084, 41059, 41061, 41082, 41086
Washing machines	Adora SL SLQ SLQ WP	11012–11014
Tumble dryers	Adora TS WP TSLQ WP	12005, 12006

3 Module description

3.1 Modes

V-ZUG-Home offers 3 different modes.

Off

In the V-ZUG-Home mode «Off», the V-ZUG-Home module is fully disabled and can only be enabled again over the household appliance.

Type of appliance	Model designation	Display
Ovens and cookers	Comhair SL SLP XSL XSLP	
	Comhair V200 ¹ V400 ¹	-
	Comhair V400 ² V600	
	Comhair V2000 V4000 V6000	Off
Steamers	Combi-Steam HSL XSL MSLQ, Comhair-Steam SL	
	Steamer V4000, CombiSteamer V4000 V6000, ComhairSteamer V2000 V6000	Off
Microwaves	CombiMiwell V2000 V4000	Off
Hobs	GK11TIFKZ/S FullFlex, GK11TIXFK FullFlex, CookTopInduction V6000 FullFlex	
Dishwashers	Adora SL SL WP	-
	AdoraDish V2000 V4000 V6000	
Washing machines	Adora SL SLQ SLQ WP	
	AdoraWash V2000 V4000 V6000	
Tumble dryers	Adora TS WP TSLQ WP	
	AdoraDry V2000 V4000 V6000, Combi-AdoraDry V4000	
Refrigerating and freezing appliances	CombiCooler V400 V2000 V4000	OF
	WineCooler V4000 45 90	OF

Display







In the V-ZUG-Home mode «Display», status information can be called up, push notifications received, time synchronized and software updated only. All other functions, such as e.g. configuring user settings, are locked.

Type of appliance	Model designation	Display
Ovens and cookers	Comhair SL SLP XSL XSLP	
	Comhair V200 ¹ V400 ¹	-
	Comhair V400 ² V600	
	Comhair V2000 V4000 V6000	Display

¹ Valid until 31 March 2022









² Valid from 1 April 2022

3 Module description

Type of appliance	Model designation	Display
Steamers	Combi-Steam HSL XSL MSLQ, Combair-Steam SL	
	Steamer V4000, CombiSteamer V4000 V6000, CombairSteamer V2000 V6000	Display
Microwaves	CombiMiwell V2000 V4000	Display
Hobs	GK11TIFKZ/S FullFlex, GK11TIXFK FullFlex, CookTopInduction V6000 FullFlex	
Dishwashers	Adora SL SL WP	-
	AdoraDish V2000 V4000 V6000	
Washing machines	Adora SL SLQ SLQ WP	
	AdoraWash V2000 V4000 V6000	
Tumble dryers	Adora TS WP TSLQ WP	
	AdoraDry V2000 V4000 V6000, Combi-AdoraDry V4000	

Operate and display / Operate

In the V-ZUG-Home mode «Operate and display» / «Operate», all functions are available.



Type of appliance	Model designation	Display
Ovens and cookers	Combair SL SLP XSL XSLP	
	Combair V200 ¹ V400 ¹	-
	Combair V400 ² V600	
	Combair V2000 V4000 V6000	Operate and display
Steamers	Combi-Steam HSL XSL MSLQ, Combair-Steam SL	
	Steamer V4000, CombiSteamer V4000 V6000, CombairSteamer V2000 V6000	Operate and display
Microwaves	CombiMiwell V2000 V4000	Operate and display
Hobs	GK11TIFKZ/S FullFlex, GK11TIXFK FullFlex, CookTopInduction V6000 FullFlex	
Dishwashers	Adora SL SL WP	-
	AdoraDish V2000 V4000 V6000	
Washing machines	Adora SL SLQ SLQ WP	
	AdoraWash V2000 V4000 V6000	
Tumble dryers	Adora TS WP TSLQ WP	
	AdoraDry V2000 V4000 V6000, Combi-AdoraDry V4000	

¹ Valid until 31 March 2022









² Valid from 1 April 2022

Type of appliance	Model designation	Display
Refrigerating and freezing appliances	CombiCooler V400 V2000 V4000	On
	WineCooler V4000 45 90	On



3.2 Symbol status

The ,  or  symbols in the display or on the operating panel of your household appliance show the networking state of the V-ZUG-Home module or the data transfer.

Ovens and cookers, steamers, microwaves, washing machines, tumble dryers, dishwashers





Symbol status	Meaning
 or  remains dark.	V-ZUG-Home mode «OFF» or «Display» is enabled. The V-ZUG-Home mode «Operate and display» or «Operate» is enabled and the household appliance is in standby mode.
 or  flashes at irregular intervals.	Data transfer is taking place.
 or  flashes every second.	There is no connection between the household appliance and the network right now. The household appliance is trying to connect to the network.
 flashes at very short intervals (only possible with CombiAir V200 ³ V400 ³).	The household appliance is in connecting mode and can be connected to the network.
 or  illuminates.	The V-ZUG-Home mode «Operate and display» or «Operate» is enabled and the household appliance is connected to the network.

Hobs

Symbol status	Meaning
 is not displayed.	V-ZUG-Home mode «Off» is enabled.
 is displayed.	There is no connection between the household appliance and the network right now. The household appliance is trying to connect to the network.
 is displayed.	Data transfer is taking place or the household appliance is connected to the network.

³ Valid until 31 March 2022

Refrigerating and freezing appliances

Symbol status	Meaning
 remains dark.	V-ZUG-Home mode «Off» is enabled.
 flashes at irregular intervals.	Data transfer is taking place.
 flashes every second.	There is no connection between the household appliance and the network right now. The household appliance is trying to connect to the network.
 illuminates.	Household appliance is connected to the network.

4 Connecting the household appliance via WLAN

Check whether your household appliance must be connected via LAN or WLAN (see page 5).

4.1 Installing the app

- ▶ Enable bluetooth and location determination on the smartphone or tablet.
- ▶ Search the Google Play™ Store or the App Store® for «V-ZUG».
- ▶ Install and open the V-ZUG App.

4.2 Enabling the V-ZUG-Home mode on the household appliance

- ▶ Enable either V-ZUG-Home or the V-ZUG-Home mode «Display» / «Operate and display» / «Operate» in the user settings of the household appliance (see page 13).

4.3 Connecting the household appliance to the home network

 When establishing a connection, stay close to your household appliance and have the password for your wireless network at the ready.

Ovens and cookers (Combair SL | SLP | XSL | XSLP | V400 * | V600 | V2000 | V4000 | V6000), steamers, microwaves, dishwashers, washing machines, tumble dryers, refrigerating and freezing appliances, hobs

* Valid from 1 April 2022

- ▶ In the V-ZUG App, add the household appliance.
 - A bluetooth pairing request appears in the V-ZUG App.
 - A 6-digit PIN appears in the display of the household appliance.
- ▶ Enter the 6-digit PIN in the V-ZUG App and confirm the bluetooth pairing request.
 - The name of the active WLAN/Wi-Fi appears in the V-ZUG App and then you are prompted to enter the WLAN/Wi-Fi password.
- ▶ Enter the WLAN/Wi-Fi password.
 - The household appliance is connected to the active WLAN/Wi-Fi connection.

 You can find further information under home.vzug.com.

Ovens and cookers (Compair V200 ** | V400 **)

** Valid until 31 March 2022

- ▶ Enable the V-ZUG-Home mode (see page 13).
 - The connecting mode is active for 60 seconds.
- ▶ In the V-ZUG App, add the household appliance.
 - The name of the active WLAN/Wi-Fi appears in the V-ZUG App and then you are prompted to enter the WLAN/Wi-Fi password.
- ▶ Enter the WLAN/Wi-Fi password.
 -  illuminates if the household appliance is successfully connected to the active WLAN/Wi-Fi.



You can find further information under home.vzug.com.

4.4 Setting up remote access



When establishing a connection, stay close to your household appliance.

To be able to also access your household appliances outside your home network, you need a V-ZUG-Home account.

Creating a V-ZUG-Home account

- ▶ Create a V-ZUG-Home account in the V-ZUG App.
 - A registration e-mail will be sent to the e-mail account you provided.
- ▶ Go to the inbox of the e-mail account, open the registration e-mail and confirm the e-mail address.
 - The V-ZUG-Home account has now been created.

Setting up remote access

- ▶ Log into the V-ZUG App with the V-ZUG-Home account.
- ▶ To set up remote access to individual household appliances, follow the instructions in the V-ZUG App.

5 Connecting the household appliance via LAN

Check whether your household appliance must be connected via LAN or WLAN (see page 5).



V-ZUG Ltd does not supply network cables, powerline adapters or wireless bridges.

5.1 Connecting the network cable

► Connect the network cable to the cable connection for the V-ZUG-Home module.

V-ZUG ovens and steam cookers:

V-ZUG hobs:

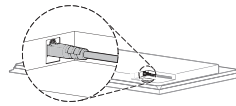
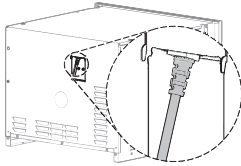

V-ZUG dishwashers:

V-ZUG washing machines and tumble dryers:

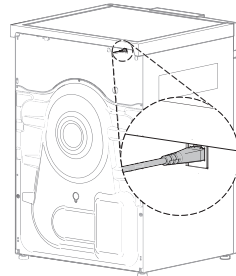
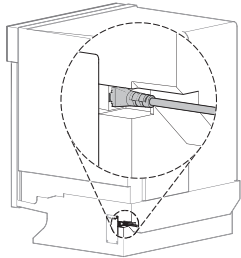

5.2 Connecting the household appliance to the home network

► Use one of the following options for connecting the household appliance to the router R:

- 1 **Ethernet:** Network cable
- 2 **Powerline adapter:** Powerline adapter and network cable
- 3 **Wireless bridge:** Wireless bridge and network cable

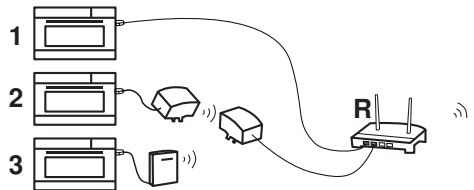

The wireless bridge must be accessible at all times.



The wireless bridge must be installed not behind the household appliance, but besides it or in an adjacent unit. Connection problems may occur if it is not positioned correctly.

5.3 Enabling the V-ZUG-Home mode on the household appliance

- ▶ Enable either V-ZUG-Home or the V-ZUG-Home mode «Display» / «Operate and display» / «Operate» in the user settings of the household appliance (see page 13).





5.4 Connecting the smartphone or tablet to the household appliance

- ▶ Search the Google Play™ Store or the App Store® for «V-ZUG».
- ▶ Install and open the V-ZUG App.
- ▶ In the V-ZUG App, add the household appliance.
 - The household appliance is displayed on the smartphone or tablet.

6 Enabling V-ZUG-Home mode

6.1 Ovens, cookers, steamers and microwaves

Comhair SL | SLP | XSL | XSLP, Combi-Steam HSL | XSL, Comhair-Steam SL and Combi-Steam MSLQ









- ▶ Touch the  touch button.
 - The user settings menu appears in the display.
- ▶ Select the  «V-ZUG-Home» user setting.
 - The main V-ZUG-Home menu appears in the display.
- ▶ Select  «V-ZUG-Home mode».
 - A selection of V-ZUG-Home modes appears in the display.
- ▶ Select  «Display V-ZUG-Home» or  «Operate and display V-ZUG-Home».
- ▶ Press the adjusting knob.
 - The setting is saved.
 - The main V-ZUG-Home menu appears in the display.
- ▶ For LAN connection: Connect the smartphone or tablet to the household appliance (see page 13).
- ▶ For WLAN connection: Connect the household appliance to the home network (see page 10).

Comhair V2000 | V4000 | V6000, Steamer V4000, CombiSteamer V4000 | V6000, ComhairSteamer V2000 | V6000 and CombiMiwell V2000 | V4000

- ▶ Long touch the display.
 - The start screen appears.
- ▶ Touch the  «User settings» and confirm with «OK» if required.
 - The user settings appear in the display.
- ▶ Select «V-ZUG-Home».
 - The «V-ZUG-Home mode» submenu appears in the display.
- ▶ Select V-ZUG-Home mode «Display» or «Operate and display».
- ▶ Connect the household appliance to the home network (see page 10).



Compair V400 * | V600

* Valid from 1 April 2022

- ▶ With the household appliance switched off, hold the  button depressed for 5 seconds.
 - The user settings can now be changed.
- ▶ Press the  button repeatedly until  appears in the digital display.
 - The light bars for the  and  symbols flash.
- ▶ Press the  button 1× or 2×.
 -  or  appears in the digital display.
 - The V-ZUG-Home mode «Display» or «Operate and display» is selected.
- ▶ Press the  button.
 - The setting is saved.
- ▶ Connect the household appliance to the home network (see page 10).





Compair V400 **

** Valid until 31 March 2022

- ▶ Hold the  and  buttons depressed at the same time for about 5 seconds.
 -  flashes.
 - The connecting mode is active for 60 seconds.
- ▶ Connect the household appliance to the home network within this time (see page 10).









Compair V200 **

** Valid until 31 March 2022















- ▶ Turn the  dial to the  position.
- ▶ Turn the  dial clockwise as far as it will go and hold in this end-stop position for at least 3 seconds.
 -  flashes.
 - The connecting mode is active for 60 seconds.
- ▶ Connect the household appliance to the home network within this time (see page 10).

6.2 Washing machines and tumble dryers

Adora SL | TS WP





- ▶ Hold the  button depressed until the serial number (FN) appears in the display.
- ▶ Press the  button repeatedly until the following appears in the display: «Configure V-ZUG-Home».
- ▶ Press the  /  button.
 - The following appears in the display: «V-ZUG-Home mode».
- ▶ Press the  button.
 - The following appears in the display: «Off».
- ▶ Press the  /  button / 1× or 2×.
 - The following appears in the display: «Display» or «Operate and display».
- ▶ Press the  button 2×.
 - The following appears in the display: «Configuration saved».
- ▶ Connect the smartphone or tablet to the household appliance (see page 13).

Adora SLQ | SLQ WP | TSLQ WP, AdoraWash, AdoraDry, CombiAdoraDry











- ▶ Close the appliance door.
- ▶ Touch the  / ... button.
- ▶ Touch the  button.
 - The user settings menu appears in the display.
- ▶ Touch the **1/4** / **1/3** / **1/2** button repeatedly until the  /  «V-ZUG-Home» user setting appears.
- ▶ Touch  /  «V-ZUG-Home».
 - The main V-ZUG-Home menu appears in the display.
- ▶ Touch the  /  «Mode».
 - A selection of V-ZUG-Home modes appears in the display.
- ▶ Touch  /  «Display» or  /  «Operate and display».
- ▶ Touch the  button.
 - The setting is saved.
- ▶ For LAN connection: Connect the smartphone or tablet to the household appliance (see page 13).
- ▶ For WLAN connection: Connect the household appliance to the home network (see page 10).

6.3 Dishwashers



Adora SL | SL WP

- ▶ Hold the  button depressed for about 5 seconds.
 - In the display appears: «User settings».
- ▶ Press the  button repeatedly until the following appears in the display: «V-ZUG-Home mode».
- ▶ Press the  button 1× or 2×.
 - In the display appears: «Display» or «Operate».
- ▶ Press the  button repeatedly until the following appears in the display: «Configuration saved».
- ▶ For LAN connection: Connect the smartphone or tablet to the household appliance (see page 13).
- ▶ For WLAN connection: Connect the household appliance to the home network (see page 10).







AdoraDish

- ▶ On the start screen, touch the  button repeatedly until  «User settings» appears.
- ▶ Touch the  button.
 - The user settings menu appears in the display.
- ▶ Touch the  button repeatedly until the  «V-ZUG-Home» user setting appears.
- ▶ Touch the  button.
 - The main V-ZUG-Home menu appears in the display.
- ▶ Touch the  «V-ZUG-Home mode» button.
 - A selection of V-ZUG-Home modes appears in the display.
- ▶ Touch the  «Display» or  «Operate» button.
 - The setting is saved.
- ▶ Touch the  button.
 - The main V-ZUG-Home menu appears in the display.
- ▶ Connect the household appliance to the home network (see page 10).

6.4 Hobs

- ▶ Touch the  button.
 - The user settings menu appears in the display.
- ▶ Swipe and tap to select the «V-ZUG-Home» user setting.
 - The main V-ZUG-Home menu appears in the display.
- ▶ Touch «Mode».
 - A selection of V-ZUG-Home modes appears in the display.
- ▶ Touch  «Display» or  «Operate and display».
 - The selected user setting is being saved.
- ▶ For LAN connection: Connect the smartphone or tablet to the household appliance (see page 13).
- ▶ For WLAN connection: Connect the household appliance to the home network (see page 10).

6.5 Refrigerating and freezing appliances

- ▶ Touch the  button.
 - The main functions and user settings menu appears in the display.
- ▶ Touch the  button repeatedly until  flashes in the display.
- ▶ Touch the OK button.
- ▶ Touch the  /  button repeatedly until «On» appears in the display.
- ▶ Touch the OK button.
 -  appears in the display.
 - The setting is saved.
- ▶ Connect the household appliance to the home network (see page 10).

7 V-ZUG-Home configuration

Here, information about the household appliance can be displayed and the V-ZUG-Home settings can be changed.





 The displays illustrated are examples.

7.1 Ovens, cookers, steamers and microwaves

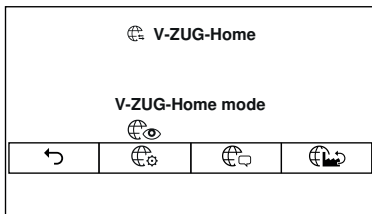
Combair SL | SLP | XSL | XSLP, Combi-Steam HSL | XSL, Combair-Steam SL and Combi-Steam MSLQ





Main V-ZUG-Home menu

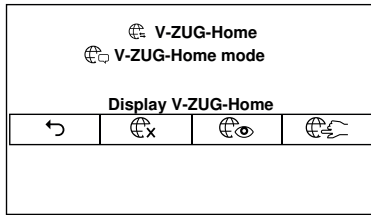

-  Back to the user settings of the household appliance /
-  Save changes made
-  V-ZUG-Home mode
-  Display information
-  V-ZUG-Home factory settings



V-ZUG-Home mode

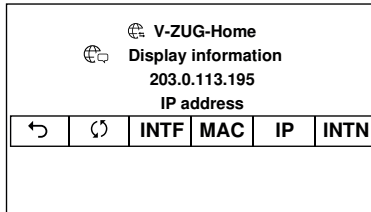

-  Back to the main V-ZUG-Home menu / Save changes made
-  V-ZUG-Home off
-  Display V-ZUG-Home
-  Operate and display V-ZUG-Home

Display information



-  Back to the main V-ZUG-Home menu
-  Start connection diagnostics
- INTF** ✓: Interface connection available
X: No interface connection available
Restart interface connection: The V-ZUG-Home module (interface) is restarted.
- MAC** MAC address
- IP** IP address
- INTN** ✓: Internet connection available
X: No internet connection available

V-ZUG-Home factory settings

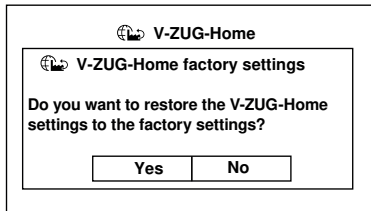

- Yes** The V-ZUG-Home settings are reset to the factory settings (see page 26). The menu is closed.
- No** The menu is closed; the configuration remains unchanged.

Compair V2000 | V4000 | V6000, Steamer V4000, CombiSteamer V4000 | V6000, CompairSteamer V2000 | V6000 and CombiMiwell V2000 | V4000

Main V-ZUG-Home menu

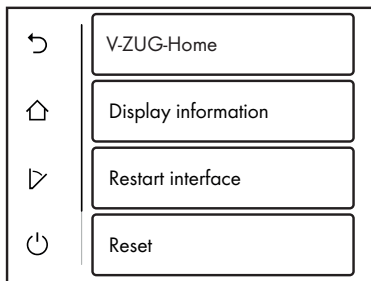

V-ZUG-Home mode

Various information

The V-ZUG-Home module (interface) is restarted.

The V-ZUG-Home settings are reset to the factory settings (see page 26).

V-ZUG-Home mode

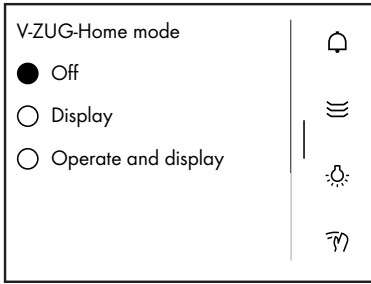

Off

Display

Operate and display

Displaying information

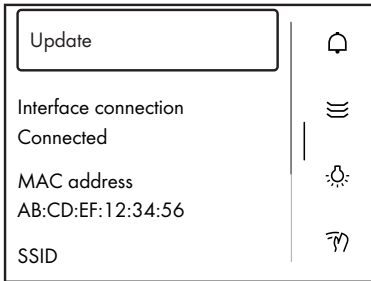

All network and appliance information is refreshed.

Not connected / Connected

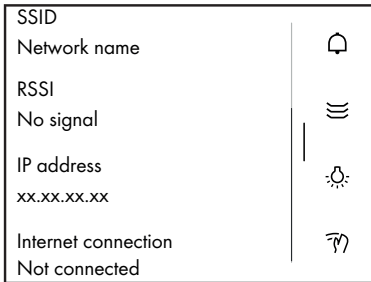

Network name

No signal / Weak signal / Medium signal / Good signal / Very good signal

Not connected / Connected

Combair V400 * | V600

* Valid from 1 April 2022



V-ZUG-Home mode «Off»



V-ZUG-Home mode «Display»



V-ZUG-Home mode «Operate and display»

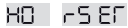

The V-ZUG-Home settings are reset to the factory settings (see page 26).

Combair V400 **

** Valid until 31 March 2022

Enabling V-ZUG-Home mode «Operate and display»

- ▶ Hold the and buttons depressed at the same time for about 5 seconds.
 - flashes.
 - The connecting mode is active for 60 seconds.
- ▶ Connect the household appliance to the home network within this time (see page 11).
 - illuminates.
 - The V-ZUG-Home mode «Operate and display» is enabled.

Enabling V-ZUG-Home mode «Off»

- ▶ Hold the and buttons depressed at the same time for about 5 seconds.
 - is no longer illuminated.
 - The V-ZUG-Home mode «Off» is enabled.





Resetting the V-ZUG-Home settings to the factory settings

- ▶ Enable V-ZUG-Home mode «Off».
- ▶ Hold the and buttons depressed at the same time for about 10 seconds.
 - flashes.
 - The V-ZUG-Home settings have been reset to the factory settings (see page 26).



Comhair V200 **

** Valid until 31 March 2022



Enabling V-ZUG-Home mode «Operate and display»

- ▶ Turn the  dial to the  position.
- ▶ Turn the °C dial clockwise as far as it will go and hold in this end-stop position for at least 3 seconds.
 -  flashes.
 - The connecting mode is active for 60 seconds.
- ▶ Connect the household appliance to the home network within this time (see page 11).
 -  illuminates.
 - The V-ZUG-Home mode «Operate and display» is enabled.

Enabling V-ZUG-Home mode «Off»

- ▶ Turn the  dial to the  position.
- ▶ Turn the °C dial clockwise as far as it will go and hold in this end-stop position for at least 3 seconds.
 -  is no longer illuminated.
 - The V-ZUG-Home mode «Off» is enabled.

Resetting the V-ZUG-Home settings to the factory settings

- ▶ Turn the  dial to the  position.
- ▶ Turn the °C dial clockwise as far as it will go (until the end-stop).
- ▶ Turn the °C dial anti-clockwise to below «250 °C».
- ▶ Turn the °C dial clockwise as far as it will go (until the end-stop).
- ▶ Turn the °C dial anti-clockwise to below «250 °C».
- ▶ Turn the °C dial clockwise as far as it will go (until the end-stop).
 -  illuminates.
 - The V-ZUG-Home settings have been reset to the factory settings (see page 26).



The temperature selector must be turned to below 250 °C twice within 6 seconds.

7.2 Washing machines and tumble dryers

Adora SL | TS WP

60 Adora SL

 Adora TS WP



- To next user setting
- Next to a submenu of V-ZUG-Home
- Save changes made
- Exit V-ZUG-Home submenu
- Back to the user settings menu

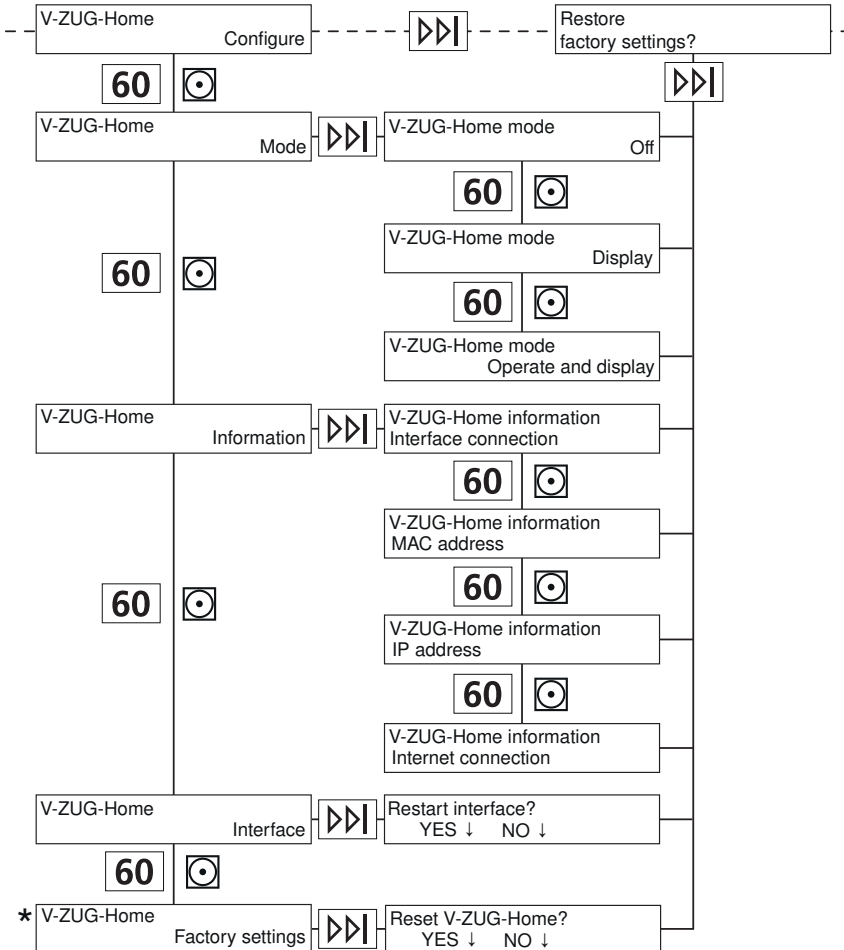

* V-ZUG-Home settings are reset to the factory settings (see page 26).

Adora SLQ | SLQ WP | TSLQ WP, AdoraWash, AdoraDry, CombiAdoraDry

Main V-ZUG-Home menu

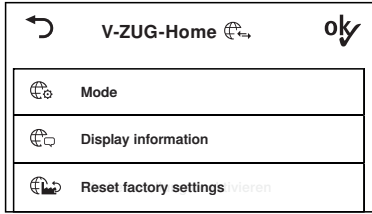

- Back to the user settings of the household appliance
- V-ZUG-Home mode
- Display information
- V-ZUG-Home factory settings
- Save changes made

V-ZUG-Home mode

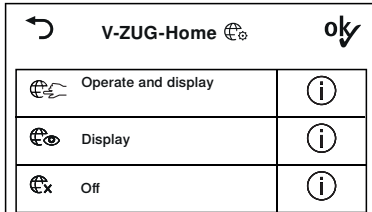

- Back to the main V-ZUG-Home menu
- Operate and display
- Display
- Off
- Save changes made

Display information

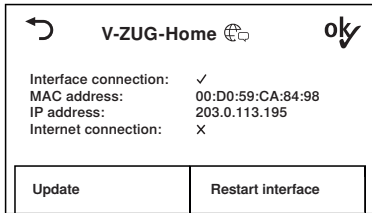

- Back to the main V-ZUG-Home menu
- Save changes made
- Interface/Internet connection available
- No interface/internet connection available

Update: Update information

Restart interface: The V-ZUG-Home module (interface) is restarted.

V-ZUG-Home factory settings

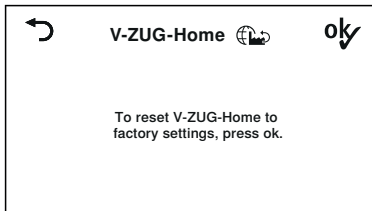

- Back to the main V-ZUG-Home menu
- The V-ZUG-Home settings are reset to the factory settings (see page 26).

7.3 Dishwashers

Adora SL | SL WP

- ▶ | ▪ Move to next user setting
- Save changes made
- ▶▶▶ ▪ Change user setting

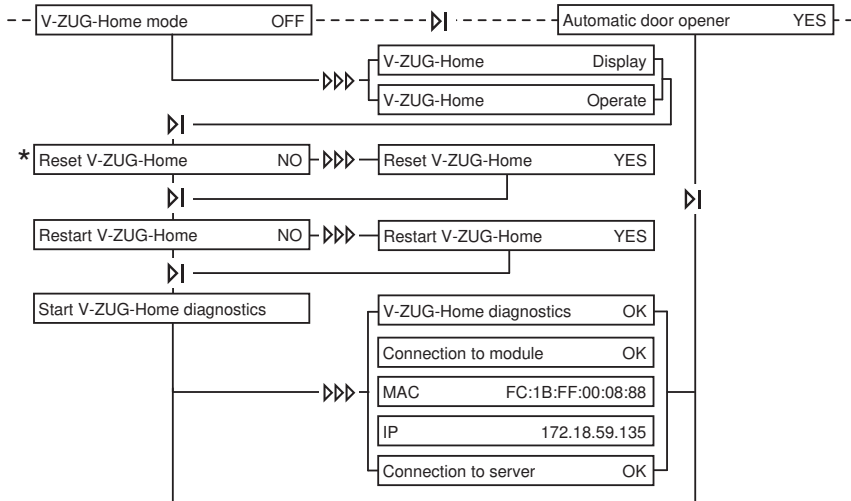

* V-ZUG-Home settings are reset to the factory settings (see page 26).

AdoraDish

Main V-ZUG-Home menu



- ↶ Back to the user settings of the household appliance
- 🏠 V-ZUG-Home factory settings
- 🌐 V-ZUG-Home information
- 📱 V-ZUG-Home mode

V-ZUG-Home mode

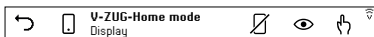



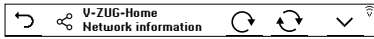

- ↶ Back to the main V-ZUG-Home menu
- 👉 Operate
- 👁️ Display
- 🗑️ Off

7 V-ZUG-Home configuration



V-ZUG-Home network information

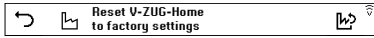

-  Back to the main V-ZUG-Home menu
-  Restart WLAN module
-  Reload network and appliance information
-  Display network and appliance information:
 - MAC address
 - IP address
 - Interface status
 - Internet status
 - WLAN SSID
 - WLAN signal strength

V-ZUG-Home factory settings





-  Back to the main V-ZUG-Home menu
-  V-ZUG-Home factory settings
-  Reset V-ZUG-Home to the factory settings

7.4 Hobs

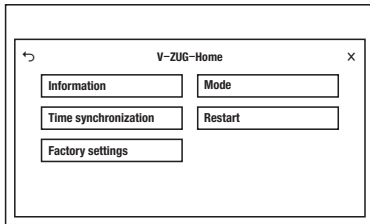





Main V-ZUG-Home menu

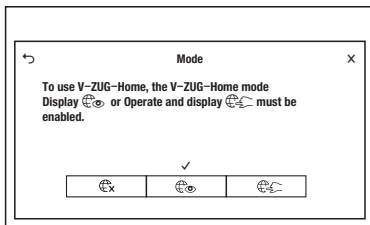

-  Back to the user settings of the household appliance
-  Exit user settings

V-ZUG-Home mode



-  Back to the user settings of the household appliance /
-  Save changes made
-  V-ZUG-Home off
-  Display V-ZUG-Home
-  Operate and display V-ZUG-Home
-  Exit user settings /
-  Save changes made

Information

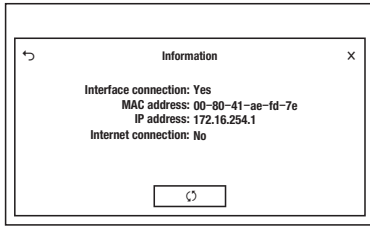

- ↶ Back to the user settings of the household appliance
- ↻ Update information
- ✕ Exit user settings

Time synchronization

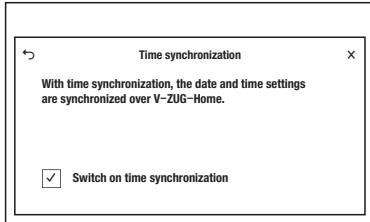

- ↶ Back to the user settings of the household appliance /
- ✓ Save changes made
- ✓ Switch on time synchronization
- ✕ Exit user settings /
- ✓ Save changes made

Restart

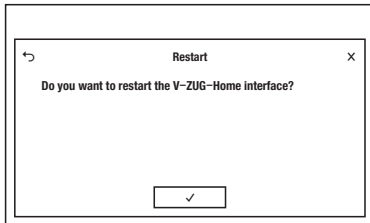

- ↶ Back to the user settings of the household appliance
- ✓ The V-ZUG-Home module (interface) is restarted. The menu is closed.
- ✕ Exit user settings

V-ZUG-Home factory settings

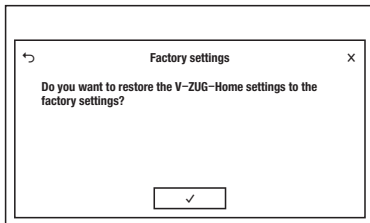

- ↶ Back to the user settings of the household appliance
- ✓ The V-ZUG-Home settings are reset to the factory settings (see page 26). The menu is closed.
- ✕ Exit user settings

7.5 Refrigerating and freezing appliances

- OF V-ZUG-Home mode «Off» is enabled.
- On V-ZUG-Home mode «Operate and display» is enabled.
- rS The V-ZUG-Home settings are reset to the factory settings (see page 26).

7.6 V-ZUG-Home factory settings

If you reset the V-ZUG-Home settings to the factory settings, depending on the connection type (see page 5) different settings are reset.

WLAN

If your household appliance must be connected via WLAN,

- automatic IP address assignment (DHCP) is enabled in the network settings and the set WLAN (SSID/PSK) is deleted,
- password protection is disabled,
- the push message history is deleted,
- the list of all connected bluetooth appliances is deleted.

LAN

If your household appliance must be connected via LAN,





- automatic IP address assignment (DHCP) is enabled in the network settings,
- password protection is disabled,
- the push message history is deleted.

8 Trouble-shooting



This section lists faults that can be solved simply by following the instructions given. If another fault is displayed or the fault cannot be remedied, please call Customer Services.

8.1 Via WLAN-connected household appliances

Malfunction	Possible cause	Solution
The V-ZUG App does not detect the new household appliance.	<ul style="list-style-type: none"> ▪ The V-ZUG-Home mode «Off» is enabled. ▪ If the problem could not be resolved: 	<ul style="list-style-type: none"> ▶ Enable V-ZUG-Home mode «Display» or «Operate and display» / «Operate» (see page 13). ▶ Restart the interface in the V-ZUG-Home user settings (see page 16). ▶ Disable and re-enable bluetooth on the smartphone or tablet.

Malfunction	Possible cause	Solution
The V-ZUG App cannot establish a connection between the household appliance and the wireless network after entering the PIN.	<ul style="list-style-type: none"> ▪ The smartphone or tablet and the household appliance are not in the same wireless network. ▪ If the problem could not be resolved: 	<ul style="list-style-type: none"> ▶ In the V-ZUG App, select the wireless network over which the smartphone or tablet is also connected. ▶ Remove the household appliance from the V-ZUG App. ▶ Add the household appliance to the V-ZUG App again. ▶ Restart the interface in the V-ZUG-Home user settings (see page 16). ▶ Delete the household appliance in the bluetooth settings of the smartphone or tablet and reconnect the household appliance via WLAN (see page 10).
 or  is not illuminated or is not displayed.	<ul style="list-style-type: none"> ▪ The V-ZUG-Home mode «Off» is enabled. 	<ul style="list-style-type: none"> ▶ Enable V-ZUG-Home mode «Display» or «Operate and display» / «Operate» (see page 13).
 or  does not stop flashing or  does not stop illuminating even though the V-ZUG-Home mode «Operate and display» / «Operate» is enabled.	<ul style="list-style-type: none"> ▪ The household appliance is not connected via WLAN. ▪ The WLAN is no longer accessible. 	<ul style="list-style-type: none"> ▶ Connect the household appliance via WLAN (see page 10).
When you log into the V-ZUG-Home account, the e-mail address or password is not recognized.	<ul style="list-style-type: none"> ▪ No V-ZUG-Home account has been created in the V-ZUG App yet. ▪ The login of the online portal (www.vzug.com) was used. 	<ul style="list-style-type: none"> ▶ No remedy necessary. ▶ Create a V-ZUG-Home account in the V-ZUG App (see page 11). ▶ Use the login of the V-ZUG-Home account.
There is no registration e-mail in the inbox of the e-mail account to create the V-ZUG-Home account.	<ul style="list-style-type: none"> ▪ The registration e-mail is in the spam or trash folder of the e-mail account. 	<ul style="list-style-type: none"> ▶ Check the spam or trash folder of the e-mail account. ▶ Open the registration e-mail and confirm the e-mail address. <ul style="list-style-type: none"> – The V-ZUG-Home account has now been created.

8.2 Via LAN-connected household appliances

Malfunction	Possible cause	Solution
 is not illuminated or is not displayed.	<ul style="list-style-type: none"> ▪ The V-ZUG-Home mode «Off» is enabled. 	<ul style="list-style-type: none"> ▶ Enable V-ZUG-Home mode «Display» or «Operate and display» / «Operate» (see page 13).
 does not stop flashing or  does not stop illuminating even though the V-ZUG-Home mode «Operate and display» or «Operate» is enabled.	<ul style="list-style-type: none"> ▪ The network cable is not connected to the cable connection for the V-ZUG-Home module. ▪ Error in home network. ▪ Data transfer is taking place or software is being updated. 	<ul style="list-style-type: none"> ▶ Check all network cable connectors and connect the household appliance via LAN (see page 12). ▶ Call Customer Services if the cable connection is not accessible. ▶ Check internet connection via smartphone or tablet. ▶ Call network technician. ▶ No remedy necessary.

9 Index

B

Before using for the first time 4

C

Comhair V200
 Enabling mode 14
 Settings in the appliance 20
Comhair V400
 Enabling mode 14
 Settings in the household appliance
 19
Comhair V600
 Enabling mode 14
 Settings in the appliance 19

D

Dishwasher
 Enabling mode 15
 Network connection 12
 Settings in the appliance 23
 Settings in the household appliance
 23
Display 7

E

Enabling mode
 Comhair V200 14
 Comhair V400 14
 Comhair V600 14
 Dishwasher 15
 Hob 16
 Microwave 13
 Oven / steam cooker 13
 Refrigerating and freezing appliances 16
 Tumble dryer 14
 Washing machine 14

H

Hob
 Enabling mode 16
 Network connection 12
 Settings in the household appliance
 24

I

Internet connection
 Checking 17, 22
 Establishing 12

L

LAN connection 12

M

Microwave
 Enabling mode 13
 Settings in the appliance 18

N

Network connection 12

O

OF 7
Off 7
On 8
Operate 8
Operate and display 8
Oven
 Network connection 12
 Settings in the household appliance
 16
Ovens
 Enabling mode 13

R

Refrigerating and freezing appliances
 Enabling mode 16
 Settings in the appliance 25

S

Safety precautions
 General 4
Safety warnings
 Before using for the first time 4
 Correct use 4
Smartphone
 Connecting to household appliance
 13
Smartphone system requirements 5
Steam cookers
 Enabling mode 13
Steamer
 Network connection 12
 Settings in the household appliance
 16
Symbol activity 9
Symbols 4

T

Tablet
 Connecting to household appliance
 13
Tablet system requirements 5
Technical questions 31
Tumble dryer

Enabling mode.....	14
Network connection	12
Settings in the appliance.....	21
Settings in the household appliance	22

V

Validity.....	2
V-ZUG App.....	10

W

Warranty extensions.....	31
Washing machine	
Enabling mode.....	14
Network connection	12
Settings in the appliance.....	21
Settings in the household appliance	22
WLAN connection	10

10 Service & Support



The «Trouble-shooting» section gives you valuable tips on how to deal with minor malfunctions yourself, saving you the time and trouble of calling out a service technician and any cost that goes along with it.

Your repair order

At www.vzug.com →Service→Service number you will find the telephone number of your nearest V-ZUG service centre.

Technical questions, accessories, warranty extensions

V-ZUG is happy to help you with any general administrative or technical queries, to take your orders for accessories and spare parts and to inform you about our progressive service agreements.



J11013503-16

V-ZUG Ltd, Industriestrasse 66, CH-6302 Zug
info@vzug.com, www.vzug.com

